

Varenummer: 204080M850A3S

Beskrivelse: E+G Justerfod
GN 40-80-M8-50-A3-S

Note: S Uden møtrik, udvendig sekskant i bunden

Mål

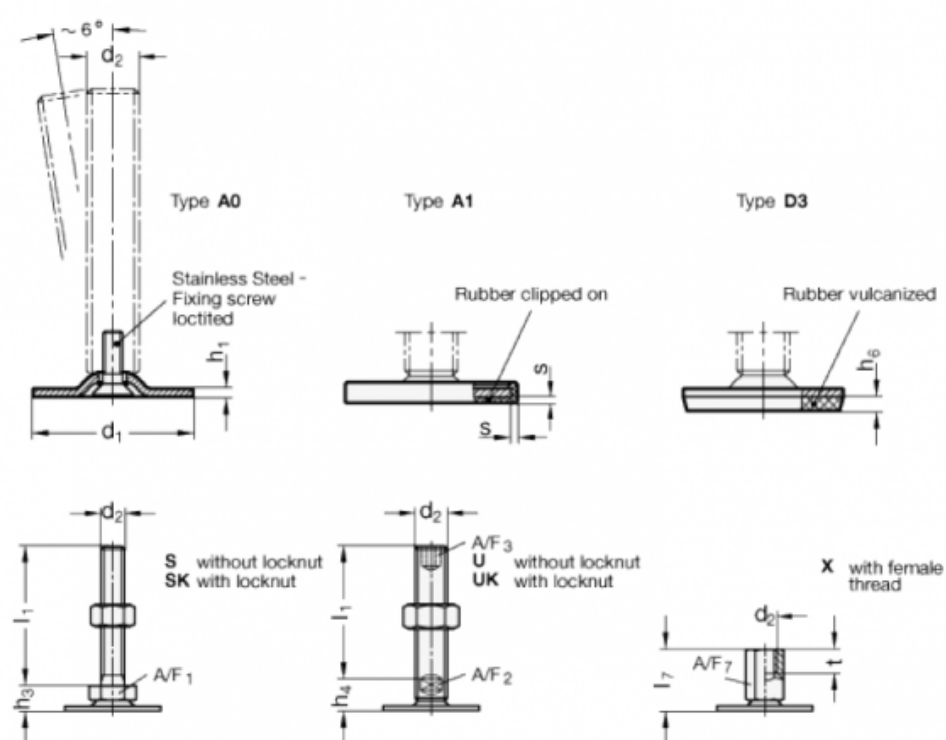

A/F1	= 17
d1	= 80
d2	= M8
h1	= 3
h3	= 12
h6	= 5
l1	= 50
s	=